

# DH-TPC-BF2120

## Thermal Network Mini Hybrid Bullet Camera



- 160x120 VOx uncooled thermal sensor technology
- Athermalized Lens (thermal camera), Focus-free
- 1/2.8" 2Megapixel progressive scan Sony CMOS
- Support ROI, Motion Detection, Color Palettes
- Support Fire detection & alarm
- Built-in 2/1 alarm in/out
- Micro SD memory, IP67



### System Overview

Featuring a dual lens, fixed bullet camera, this series provides an all-in-one solution for capturing video surveillance for indoor and outdoor applications. Together with Thermal and Visible Technology, the camera is the perfect solution for dark, small area monitoring applications. The series combines one thermal camera for monitoring in total darkness and one visible camera with Smart IR for confirming details.

### Functions

#### Uncooled Vox Technology

Dahua thermal cameras use uncooled Vox sensor technology. Because of small size and better performance, it's cost-effective solution for thermal security.

#### High Sensitivity

High thermal sensitivity(<50mK) makes cameras capture more image details and temperature difference information.

#### Fire Detection & Alarm

With built-in Fire detect function, the camera has the ability to detect fire in a long distance. because thermal camera is sensitive to temperature, so the accuracy of fire detection will be higher than visible camera.

### Intelligent Video System (IVS)

With built-in intelligent video analytics, the camera has the ability to detect and analyze moving objects for improved video surveillance. The camera provides optional standard intelligence at the edge allowing detection of multiple object behaviors such as abandoned or missing objects. IVS also supports Tripwire analytics, allowing the camera to detect when a pre-determined line has been crossed.

### Environmental

With a temperature range of -30 °C to +55 °C (-22 °F to +131 °F), the camera is designed for extreme temperature environments. Subjected and certified to rigorous dust and water immersion tests, the IP67 rating makes it suitable for demanding outdoor applications.

### Protection

Supporting  $\pm 15\%$  input voltage tolerance, this camera suits even the most unstable conditions for outdoor applications. Its 6KV lightning rating provides protection against the camera and its structure from the effects of lightning.

### Technical Specification

#### Thermal Camera

Image Sensor	Uncooled VOx Microbolometer
Effective Pixels	160(H)x120(V)
Pixel Size	12um
Thermal Sensitivity (NETD)	<50mK@f/1.1
Spectral Range	7~14um
Image Setting	Brightness/Sharpness/ROI/AGC/FFC/3D DNR
Color Palettes	14(Whitehot/Blackhot/Ironrow/Icefire/Fusion/Rainbow/Globow/Iconbow1/Iconbow2 .etc)

#### Thermal Lens

Lens Type	Fixed
Focus Control	Athermalized, Focus-free
Focal Length	1mm
Effective Distance ① Man(1.8m*0.5m)	D②: 60m R③: 20m I④: 10m
Effective Distance Vehicle(2.3m*2.3m)	D: 200m R: 60m I: 30m
Angle of View	H: 56° V: 44°

#### Visible Camera

Image Sensor	1/2.8" 2M CMOS
Effective Pixels	1944(H)x1092(V)
Electronic Shutter Speed	1/1 ~ 1/30,000s
Min. Illumination	Color: 0.005Lux@F1.8; B/W: 0.0005Lux@F1.8; 0Lux (IR on)
IR Distance	35m
IR On/Off Control	Auto/Manual
IR LEDs	1

#### Visible Lens

Focal Length	4mm
Max Aperture	F1.8
Angle of View	H: 74.8° V: 44.7°

#### Video

Compression	H.264/MJPEG
Frame Rate	Main Stream: Thermal: 1280*960 (default)/720P@1~25/30fps Visible: 1080P (default)/720P@1~25/30fps  Sub Stream: Thermal: 640*480 (default)/ 320*240@1~25/30fps Visible: CIF(default)/D1@1~25/30fps
Bit Rate Control	CBR/VBR
Bit Rate	H.264: 640 ~ 8192Kbps
Day/Night	Auto(ICR)/Color/B/W
BLC Mode	BLC/HLC/WDR
White Balance	Auto, Manual
Noise Reduction	Ultra DNR
Motion Detetion	Off/On (4 zone, Rectangle)
Region of Interest	Off/On (4 zone)
Electronic Image Stabilization (EIS)	NA
Defog	Off/On
Flip	180°
Mirror	Off/On
Privacy Masking	Off/On (4 area, Rectangle)

#### Audio

Compression	G.711a/G.711Mu/AAC
-------------	--------------------

#### Intelligence

IVS	Tripwire, Intrusion, Object Abandon/Missing
Advanced Intelligent Functions	Fire detection & alarm, Image Fusion

#### Network

Ethernet	RJ-45 (10/100Base-T)
Protocol	IPv4/IPv6, HTTP, HTTPS, SSL, TCP/IP, UDP, UPnP, ICMP, IGMP, SNMP, RTSP, RTP, SMTP, NTP, DHCP, DNS, PPPoE, DDNS, FTP, IP Filter, QoS, Bonjour, 802.1x
Interoperability	ONVIF Profile S & G, PSIA, CGI
Streaming Method	Unicast/Multicast
Max. User Access	10 Users/20 Users
Edge Storage	micro SD (128GB) Memory status display (Normal/Error/Active/Formatting/Lock), NAS (Network Attached Storage), Local PC for instant recording
Web Viewer	<IE11, <Chrome45, <Firefox52
Management Software	Smart PSS, DSS
Smart Phone	Android, IOS

Certifications

Certification	CE (EN 60950:2000) FCC (FCC Part 15 Subpart B)
Interface	
Video Interface	1.0Vp-p/75Ω, PAL/NTSC (HDCVI Optional)
Audio Interface	In/Out 1/1
RS485	Support
Alarm	2/1 In/Out

Electrical

Power Supply	DC 12V/PoE
Power Consumption	12W (IR on), 9W (IR off)

Environmental

Operating Condition	-30°C ~ +55°C (-22°F ~ +131°F)/Less than 95% RH * Start up should be done at above -30°C (-22°F)
Storage Conditions	-40°C ~ +70°C (-40°F ~ +158°F)/Less than 95% RH
Ingress Protection	IP67

Construction

Casing	Metal
Dimensions	238.6mm × 90.4mm × 90.4mm (9.39" x 3.56" x 3.56") (With bracket)
Weight	< 1Kg

- Note:
- ① Effective distance values shown are nominal values and should be used as estimates only. Exact value calculations depend on a wide variety of conditions.
  - ② D: Detection Distance
  - ③ R: Recognition Distance
  - ④ I: Identification Distance

Ordering Information

Type	Part Number	Description
DH-TPC-BF2120	DH-TPC-BF2120P-1F4 DH-TPC-BF2120N-1F4	Thermal: 160x120 1mm lens Visible: 2MP 4mm lens

Accessories

Optional:



PFA122



PFA152-E

Mounting Type

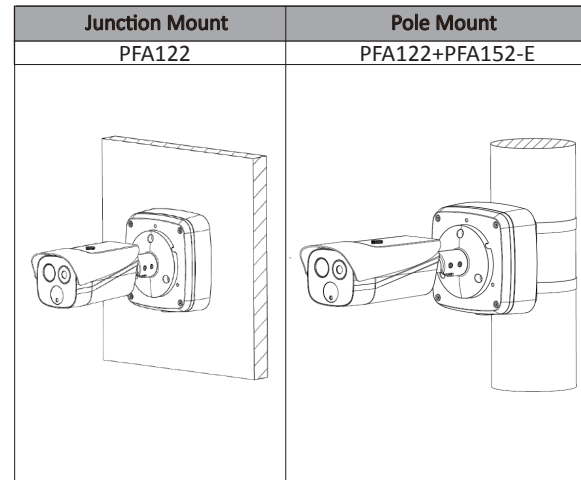

Dimensions (mm)

